

MAX WeldClean

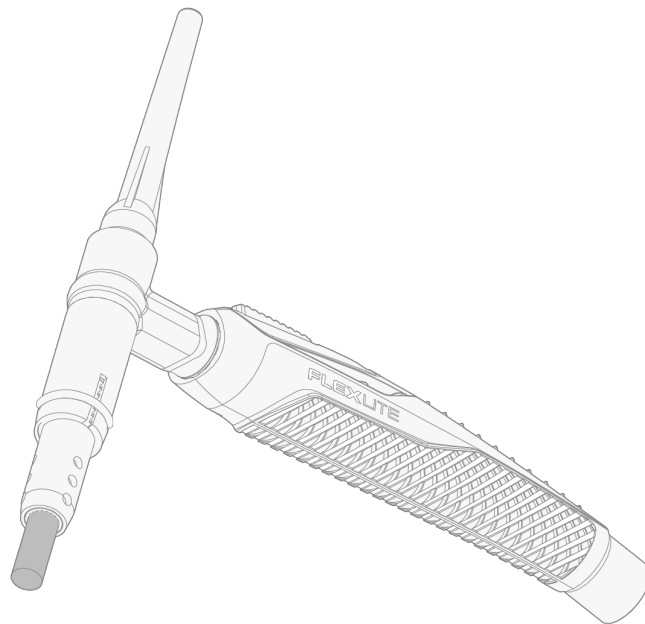

CONTENTS

1. General	3
1.1 About equipment	5
2. Installation	6
3. Operation	9
4. Maintenance	11
4.1 Disposal	12
4.2 Troubleshooting	13
5. Technical data	14
6. Ordering codes	15

1. GENERAL

These instructions describe the use of Kemppi's MAX WeldClean cleaning kit for post-weld electrolytic cleaning. This method is used to restore the corrosion protection of stainless steel welds by removing contaminants from and correcting discoloration on weld seams. The MAX WeldClean cleaning kit is intended for professional use.

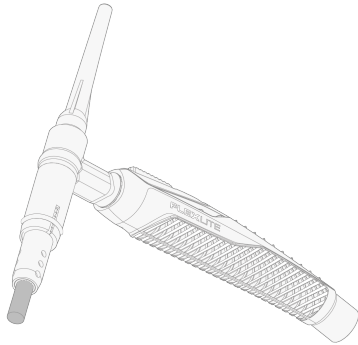

The MAX WeldClean cleaning kit is compatible with the following Kemppi Flexlite TX welding torch models:

- TX 165 G, TX 165 GF
- TX 163 GF, TX 163 GVD09
- TX 225 G, TX 225 GF, TX 225 GS, TX 225 GFL
- TX 223 G, TX 223 GS, TX 223 GE, TX 223 GVD13
- TX 355 W
- TX 353 W, TX 353 WSE
- TX 455 W.

For more information on Flexlite TX welding torches, refer to [Kemppi Userdoc](#).

The MAX WeldClean cleaning kit is compatible with the following Kemppi welding devices:

- Minarc T 223 ACDC (for more information, refer to [Kemppi Userdoc](#)).

Important notes

Read the instructions through carefully. For your own safety, and that of your working environment, pay particular attention to the safety instructions delivered with the equipment.

Items in the manual that require particular attention in order to minimize damage and harm are indicated with the below symbols. Read these sections carefully and follow their instructions.

 *Note: Gives the user a useful piece of information.*

 *Caution: Describes a situation that may result in damage to the equipment or system.*

 *Warning: Describes a potentially dangerous situation. If not avoided, it will result in personal damage or fatal injury.*

Kemppi symbols: [Userdoc](#).

DISCLAIMER

While every effort has been made to ensure that the information contained in this guide is accurate and complete, no liability can be accepted for any errors or omissions. Kemppi reserves the right to change the specification of the product described at any time without prior notice. Do not copy, record, reproduce or transmit the contents of this guide without prior permission from Kemppi.

1.1 About equipment



The Kemppi MAX WeldClean cleaning kit contains a cleaning tool, a container for cleaning liquid and a pressure spray bottle for neutralization liquid.

i *The cleaning and neutralization liquids are not included in the MAX WeldClean cleaning kit.*

The MAX WeldClean cleaning tool is available in sizes S (Standard) and L (Large).



2. INSTALLATION

-  *Ensure that the welding equipment is not connected to the mains or that the welding torch is not connected to the welding machine at this stage.*
-  *Protect the equipment from rain and direct sunshine.*
-  *For information on connecting the Flexlite TX welding torch to the welding power source, refer to [Kempfi Userdoc](#).*

1. Install the collet to the collet body.

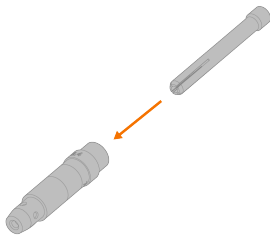

2. Install the collet assembly to the torch and tighten it in place.

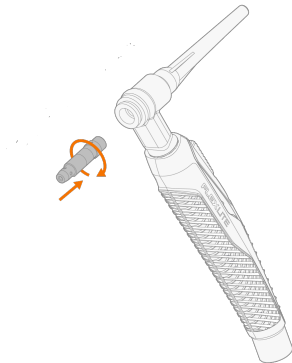

3. Install the inner brush sleeve into the outer brush sleeve and tighten it in place. Make sure that the inner brush sleeve is completely inside the outer brush sleeve (no sleeve threads are visible).

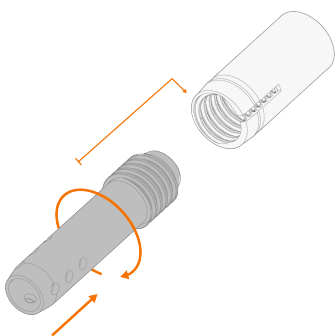

Size S

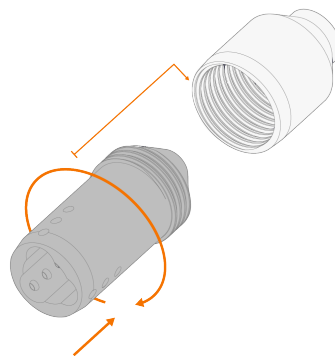

Size L

4. Install the sleeve assembly.

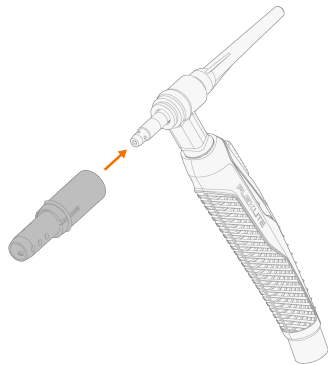

Size S

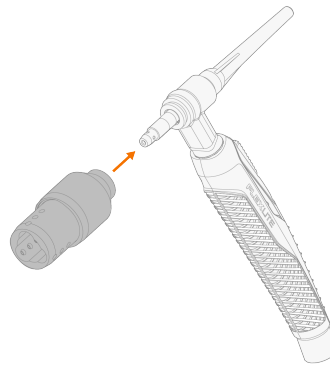

Size L

5. Install the brush to the brush adapter and tighten it in place (there are three brushes in size L).

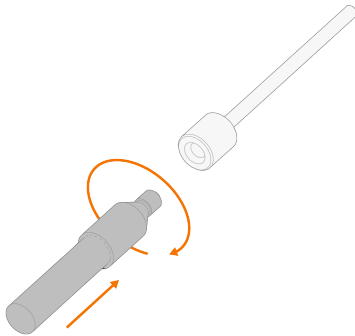

Size S

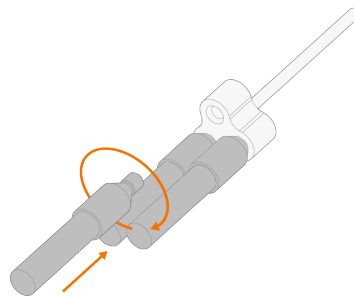

Size L

6. Install the brush adapter and tighten the back cap to lock it in place.

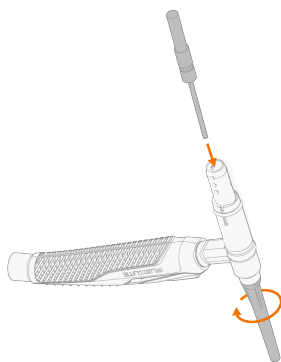

Size S

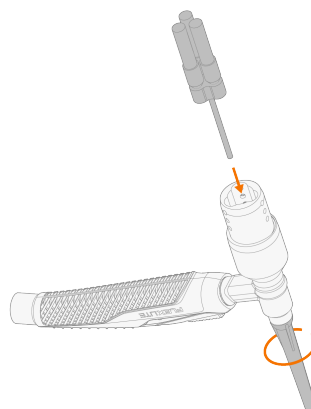

Size L

- Adjust the desired length of the brush by rotating the inner brush sleeve in size S and the outer brush sleeve in size L.

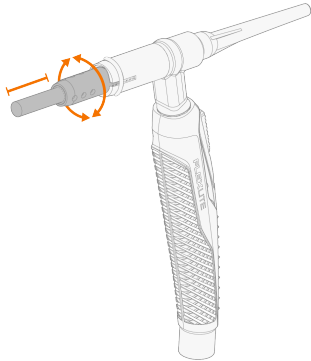

Size S

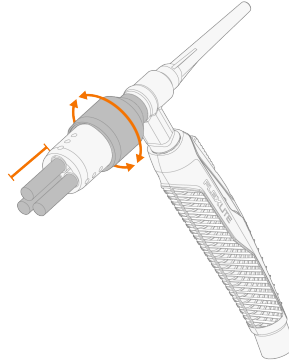





Size L



The appropriate brush length depends on the application. As a general guideline, it is advisable to use a relatively short length (5...10 mm). This ensures there is sufficient length for the bristles to flex into all required areas, while avoiding inaccuracies associated with excessive length.

3. OPERATION

-  Pay attention to your own safety and the safety of others in the work environment.
-  Ensure proper ventilation and use personal respiratory protection.
-  Wear suitable protective clothing, including eye, face and hand protection. Use protective gloves that are specifically designed for handling chemicals, such as phosphoric acids, and that comply with the EN ISO 374-1:2016 standard. Also, follow the safety guidelines and recommendations provided by the manufacturer of the chemicals you use.
-  Always check before use that earth return lead/clamp and mains cable are in serviceable condition. Ensure that the connectors are correctly fastened.
-  Choose the cleaning liquid (e.g., 10...60 % phosphoric acid) and the neutralization liquid (e.g., water) based on the application. The cleaning and neutralization liquids are not included in the MAX WeldClean cleaning kit.

To clean a weld:

1. Close the shielding gas valve.
 2. Ensure that the earth return cable is connected to the power source and work piece.
 3. In the welding device, select the cleaning or polishing process (for more information, refer to [Kempfi Userdoc](#)).
 4. Adjust the current.
-  The default current for cleaning and polishing is 25 A. With the L-size cleaning tool, a good starting point for finding a suitable current is 50 A. In general, the current is suitable when the cleaning is relatively fast and the formation of fumes is low.
5. Dip the brush into the cleaning liquid. Ensure that both the brush and the surface to be cleaned are sufficiently moist throughout the cleaning process.



6. Apply the brush to the work piece and ignite the current by pressing the ON/OFF switch on the torch handle.

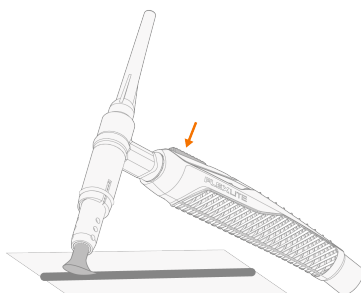

- i** Choose the cleaning technique based on the application. A suitable technique is to move the brush slowly back and forth in a painting motion. Which ever technique you choose, always ensure that the brush does not come off the work piece during cleaning.
- 7.** To stop cleaning, turn off the current and lift the brush away from the work piece.
 - 8.** Finally, neutralize the cleaned area with the neutralization liquid and wipe dry.



- i** Wash and rinse the cleaning equipment thoroughly after use to avoid acid damage and to keep the equipment in good condition for future use.

4. MAINTENANCE



Disconnect the power source from the mains power supply before handling electrical cables.

- Check regularly that all the components are tightly fastened.
- Rinse the cleaning brush under running water to maintain cleanliness and reusability.

For repairs, contact your Kemppi dealer.



Do not use pressure washing devices.

Service workshops

Kemppi Service Workshops complete the welding system maintenance according to the Kemppi service agreement.

The main aspects in the service workshop maintenance procedure are:

- Cleanup of the machine
- Maintenance of the welding tools
- Checkup of the connectors and switches
- Checkup of all electric connections
- Checkup of the power source mains cable and plug
- Repair of defective parts and replacement of defective components
- Maintenance test
- Test and calibration of operation and performance values when needed.

Find your closest service workshop at Kemppi website.

4.1 Disposal



Do not dispose of any electrical equipment with normal waste!

In observance of WEEE Directive 2012/19/EU on waste of electrical and electronic equipment and European Directive 2011/65/EU on the restriction of the use of certain hazardous substances in electrical and electronic equipment, and their implementation in accordance with national law, electrical equipment that has reached the end of its life must be collected separately and taken to an appropriate environmentally responsible recycling facility. The owner of the equipment is obliged to deliver a decommissioned unit to a regional collection center, as per the instructions of local authorities or a Kemppi representative. By applying these European Directives you improve the environment and human health.

For more information:



4.2 Troubleshooting

 *The problems and the possible causes listed are not definitive, but suggest some typical situations that may turn up during normal use of the welding system. For further information and assistance, contact your nearest Kempfi service workshop.*

The torch overheats:

- Make sure the torch body is properly connected.
- Make sure that the parameters are within the range of the torch. If different torch components have separate limits for the maximum current; the lower one of these is the maximum current that can be used.
- Make sure you are using original Kempfi consumable and spare parts. Incorrect spare part materials may also cause overheating.
- Make sure the connectors are clean, undamaged and properly fastened.

5. TECHNICAL DATA

MAX WeldClean		
Feature		Value
Default current		Size S: 25 A Size L: 50 A
Operating temperature range	Does not apply to liquids	-20...+40 °C
Compatible Flexlite TX TIG welding torches		TX 165 G, TX 165 GF TX 163 GF, TX 163 GVD09 TX 225 G, TX 225 GF, TX 225 GS, TX 225 GFL TX 223 G, TX 223 GS, TX 223 GE, TX 223 GVD13 TX 355 W TX 353 W, TX 353 WSE TX 455 W

6. ORDERING CODES

For MAX WeldClean ordering information, refer to [Kemppi.com](https://www.kemppi.com).